

HIQ GRMS

Wiring diagram

Drawing

Version

Date

GRMS-001

v1.0.0

4/6/2024

Supplier

Customer

Robotina d.o.o.

OIC Hrpelje 38

6240 Kozina, Slovenia

info@robotina.com

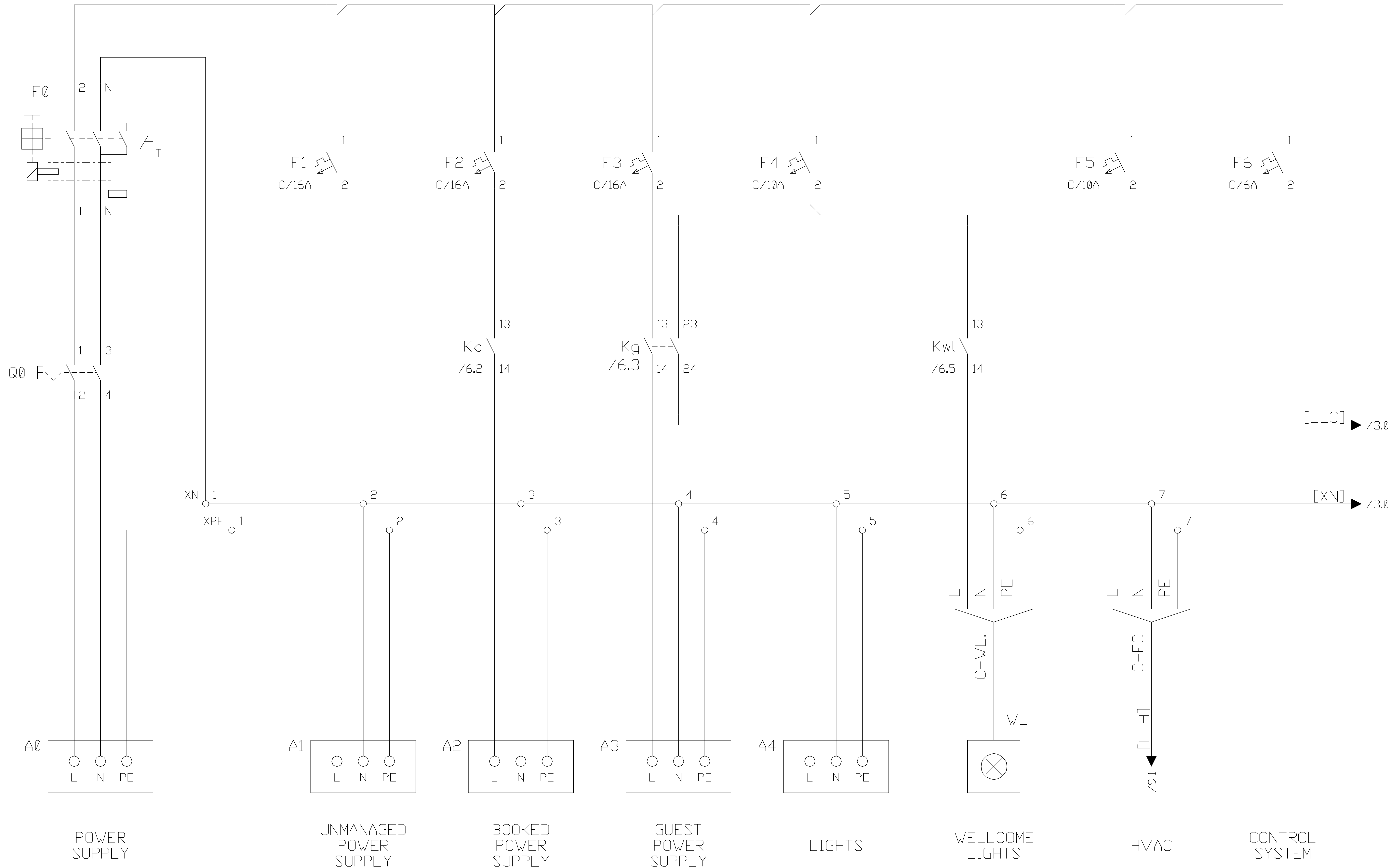

				Last changed by GK	 Robotina d.o.o. OIC Kozina 38 SI-6240 Kozina	POWER DISTRIBUTION	Drawing number GRMS-001	Installation =
				Last changed 4/6/2024		HIQ GRMS	Pages 12	Location +
Rev	Revision text	Signature	Date	Print date 4/6/2024				Page number 2

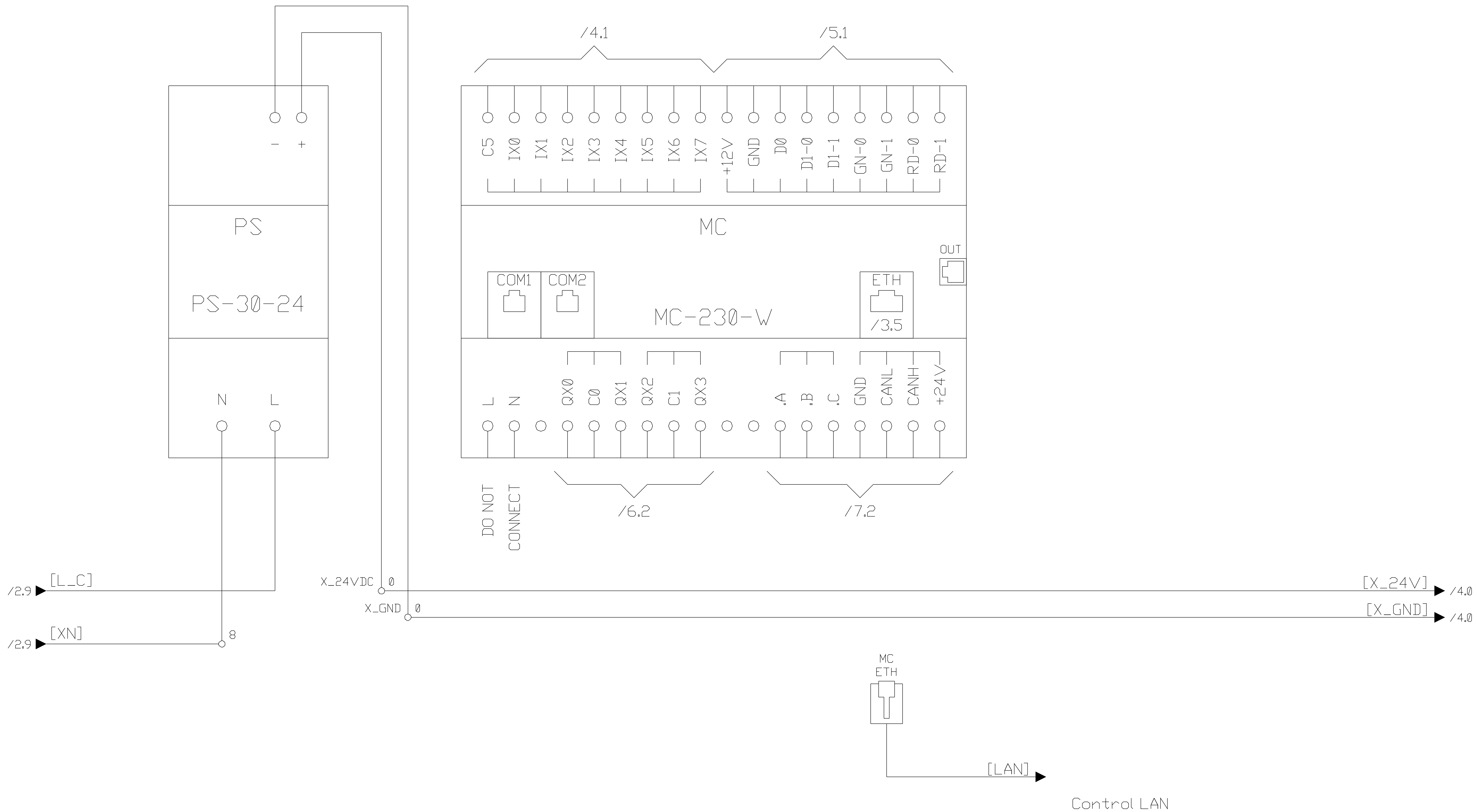

				Last changed by GK	 Robotina d.o.o. OIC Kozina 38 SI-6240 Kozina	CONTROL SYSTEM	Drawing number GRMS-001	Installation =
				Last changed 4/6/2024		HIQ GRMS	Pages 12	Location +
Rev	Revision text	Signature	Date	Print date 4/6/2024				Page number 3

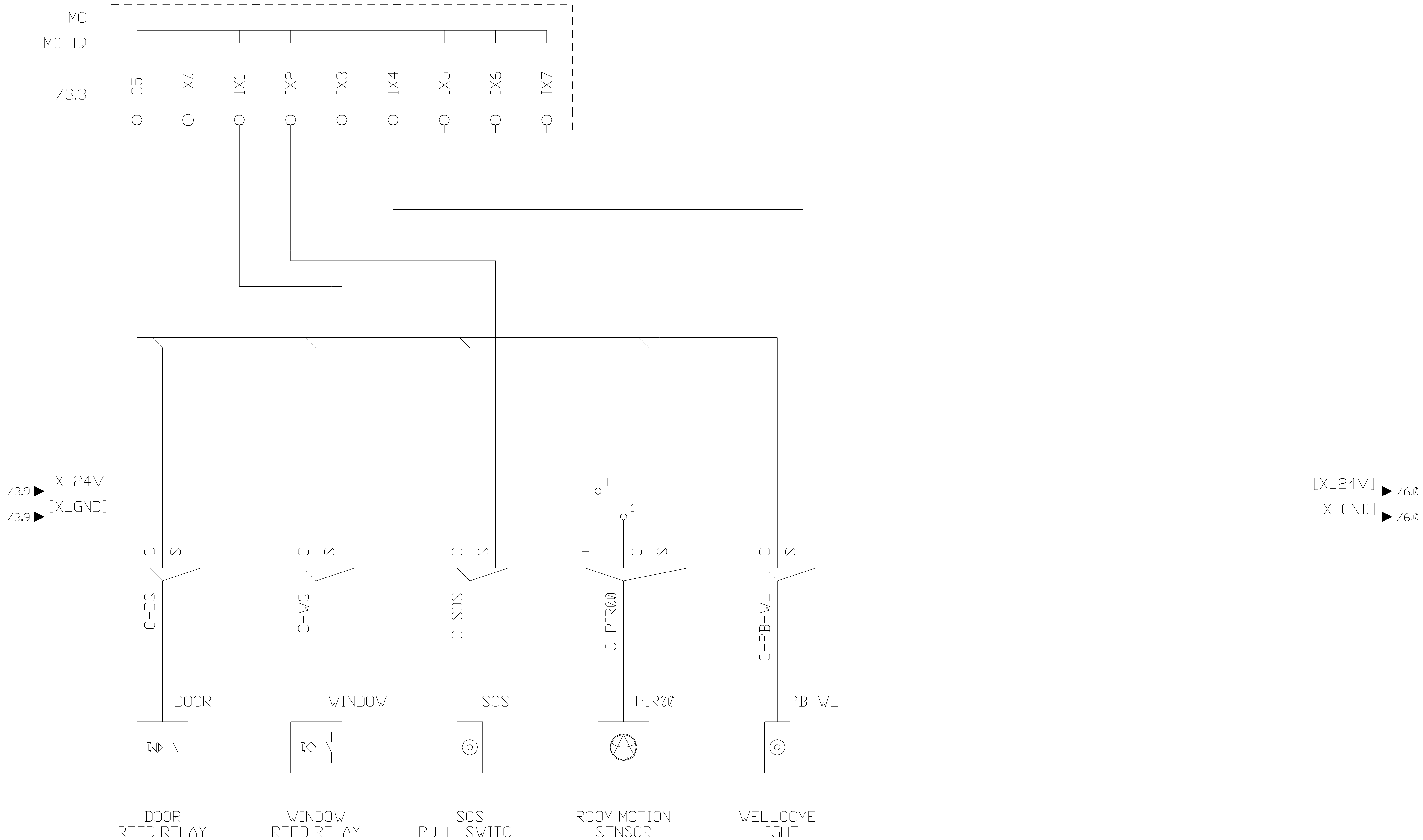

Rev	Revision text	Signature	Date
-----	---------------	-----------	------

Last changed by	GK
Last changed	4/6/2024
Print date	4/6/2024



CONTROL SYSTEM  
HIQ GRMS

Drawing number	GRMS-001
Pages	12

Installation =	Location +	Page number 4
----------------	------------	---------------

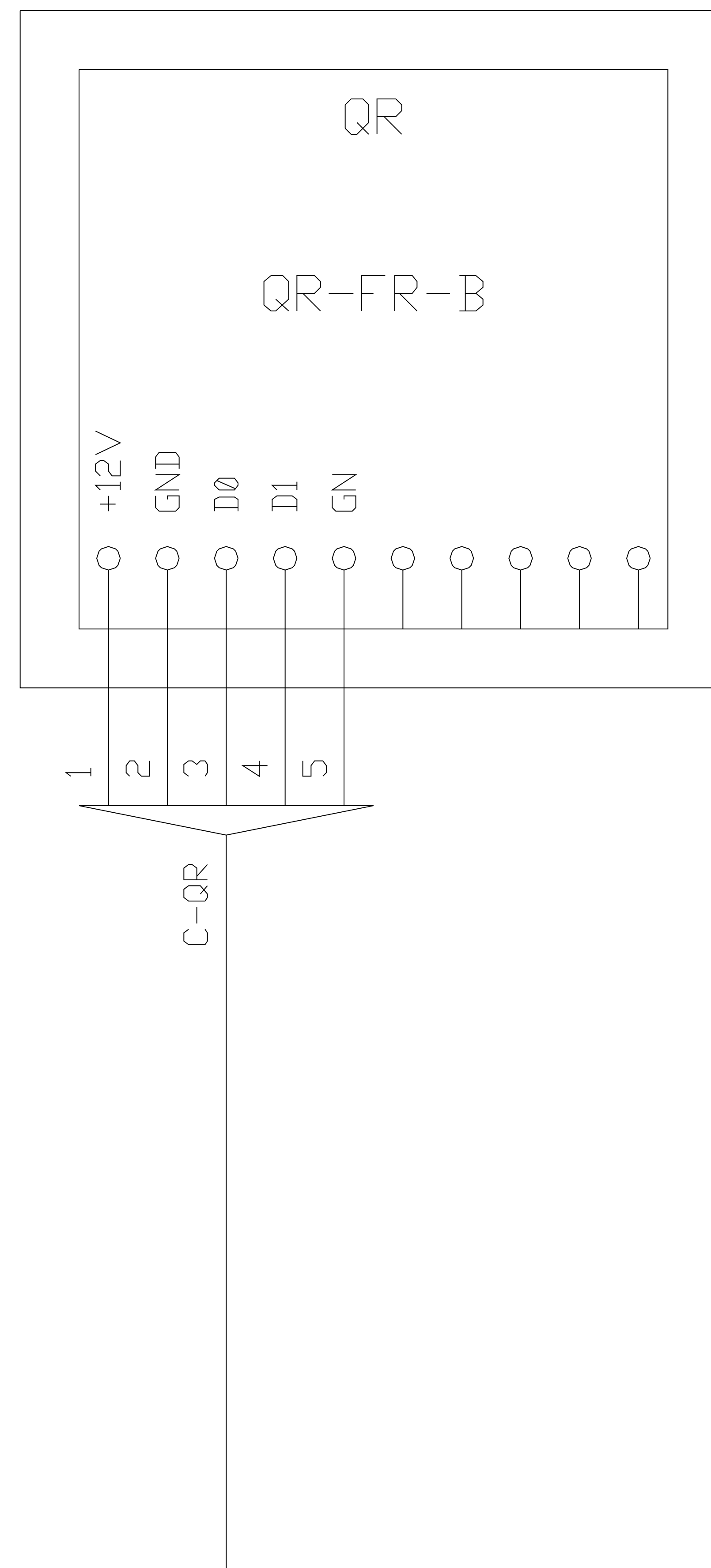
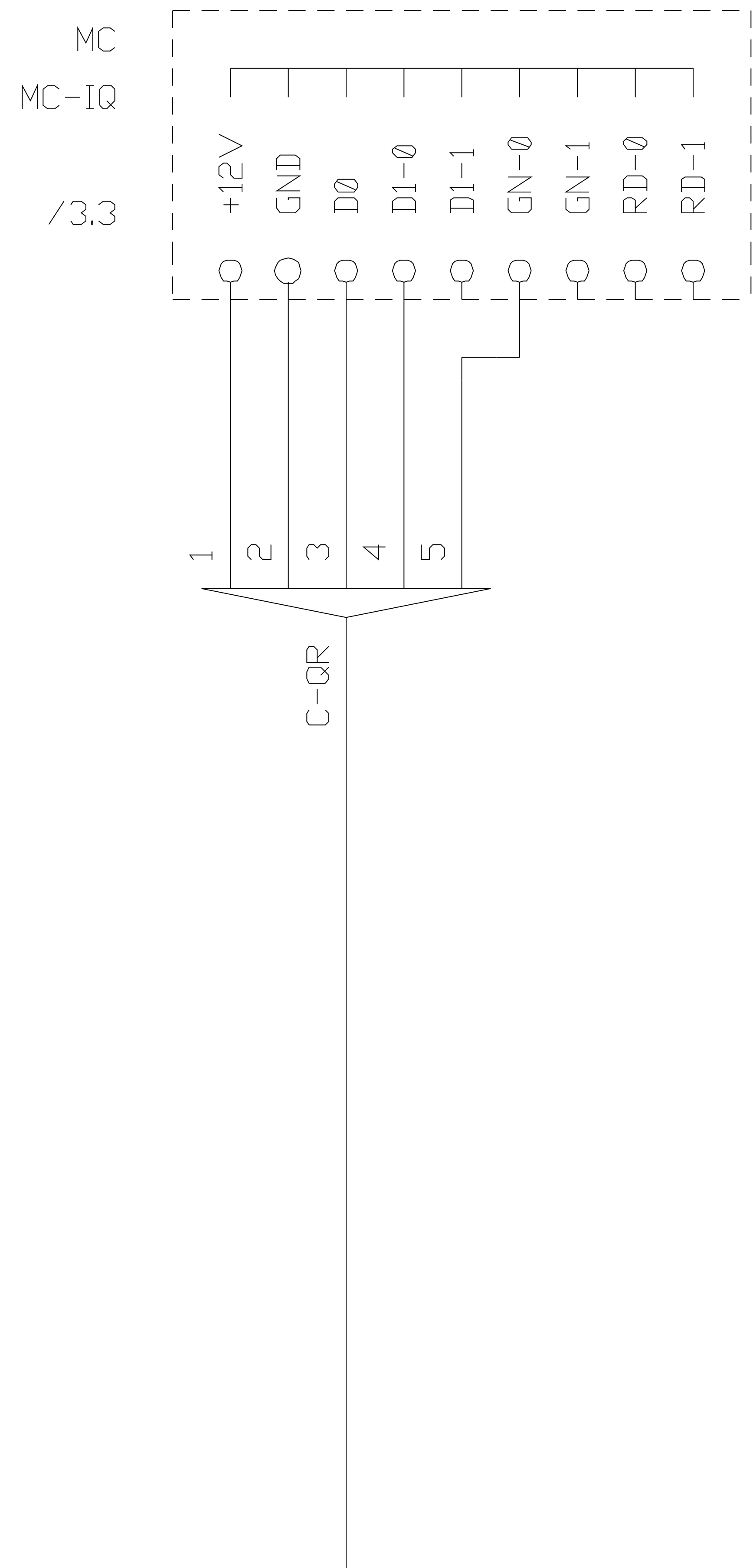

QR & RFID KEY-CODE READER

				Last changed by GK	 Robotina d.o.o. OIC Kozina 38 SI-6240 Kozina	CONTROL SYSTEM	Drawing number GRMS-001	Installation =
				Last changed 22/5/2024		HIQ GRMS	Pages 12	Location +
Rev	Revision text	Signature	Date	Print date 4/6/2024				Page number 5

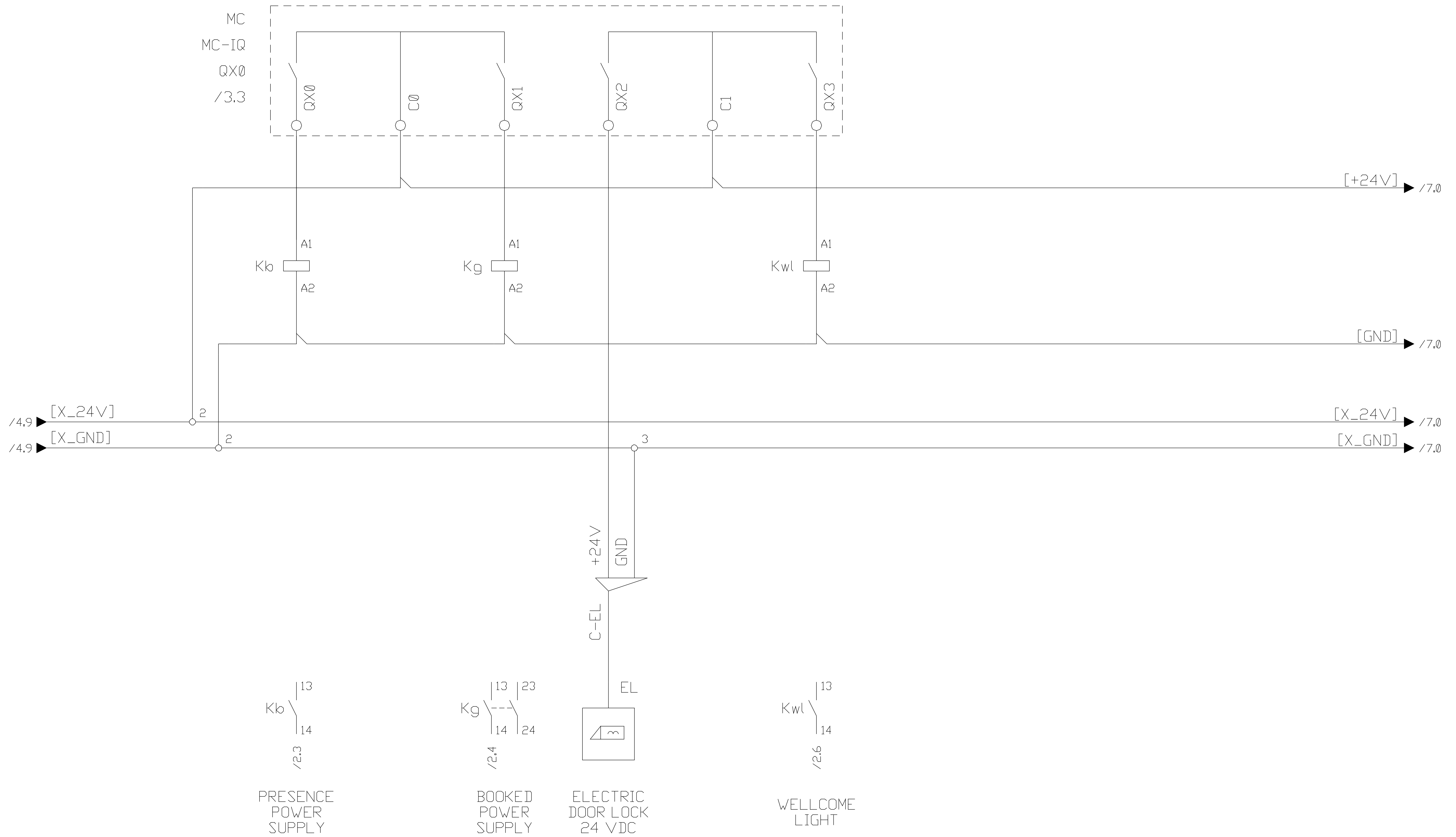

				Last changed by GK	 Robotina d.o.o. OIC Kozina 38 SI-6240 Kozina	CONTROL SYSTEM	Drawing number GRMS-001	Installation =
				Last changed 4/6/2024		HIQ GRMS		Location +
				Print date 4/6/2024				
Rev	Revision text	Signature	Date				Pages 12	Page number 6

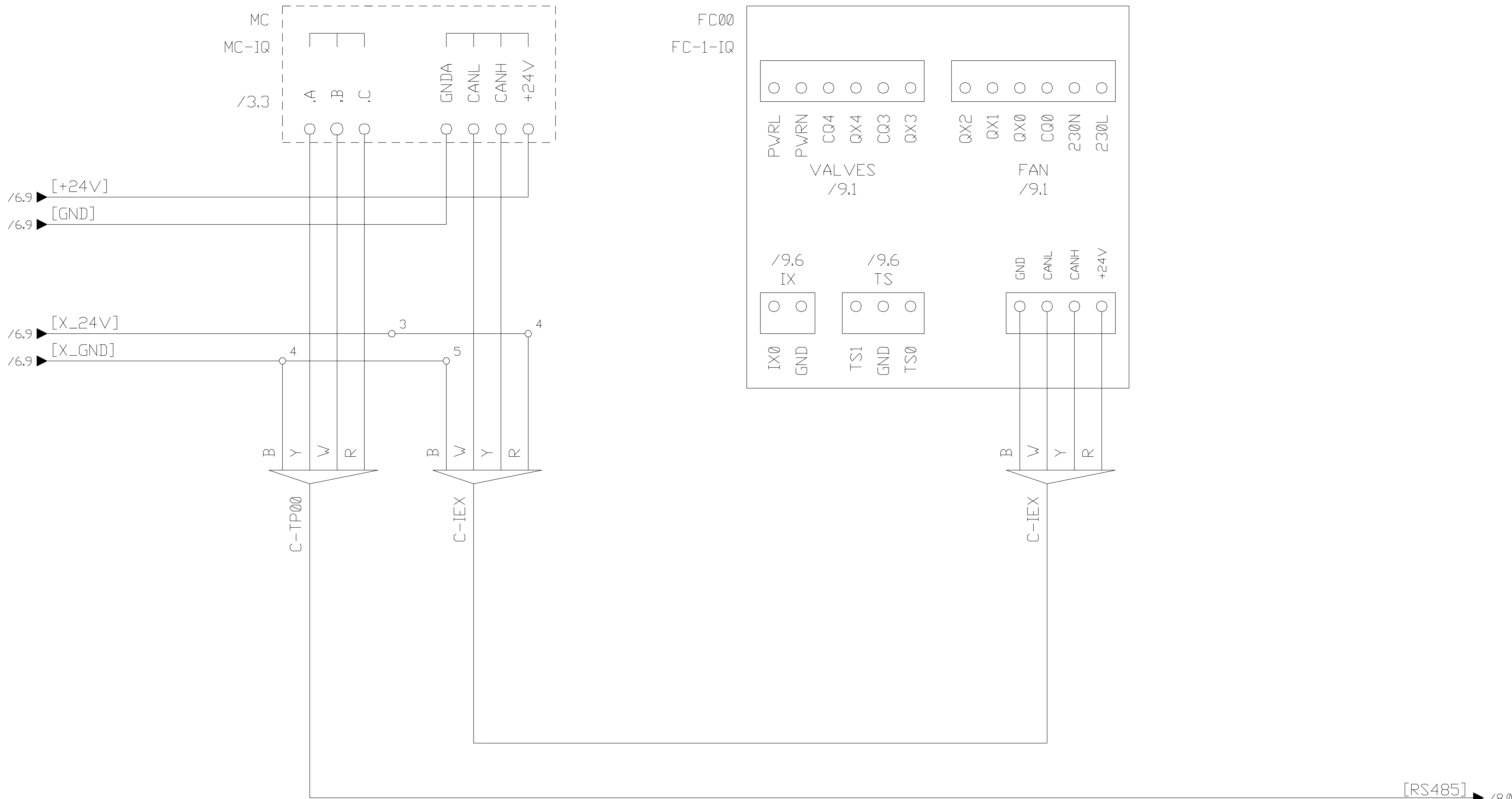

FAN-COIL CONTROLLER

Rev	Revision text	Signature	Date	Last changed by GK	 Robotina d.o.o. OIC Kozina 38 SI-6240 Kozina	CONTROL SYSTEM	Drawing number GRMS-001	Installation =
				Last changed 4/6/2024		HIQ GRMS		Location +
				Print date 4/6/2024			Pages 12	Page number 7

TGP00  
TGP-4A-01-IQ

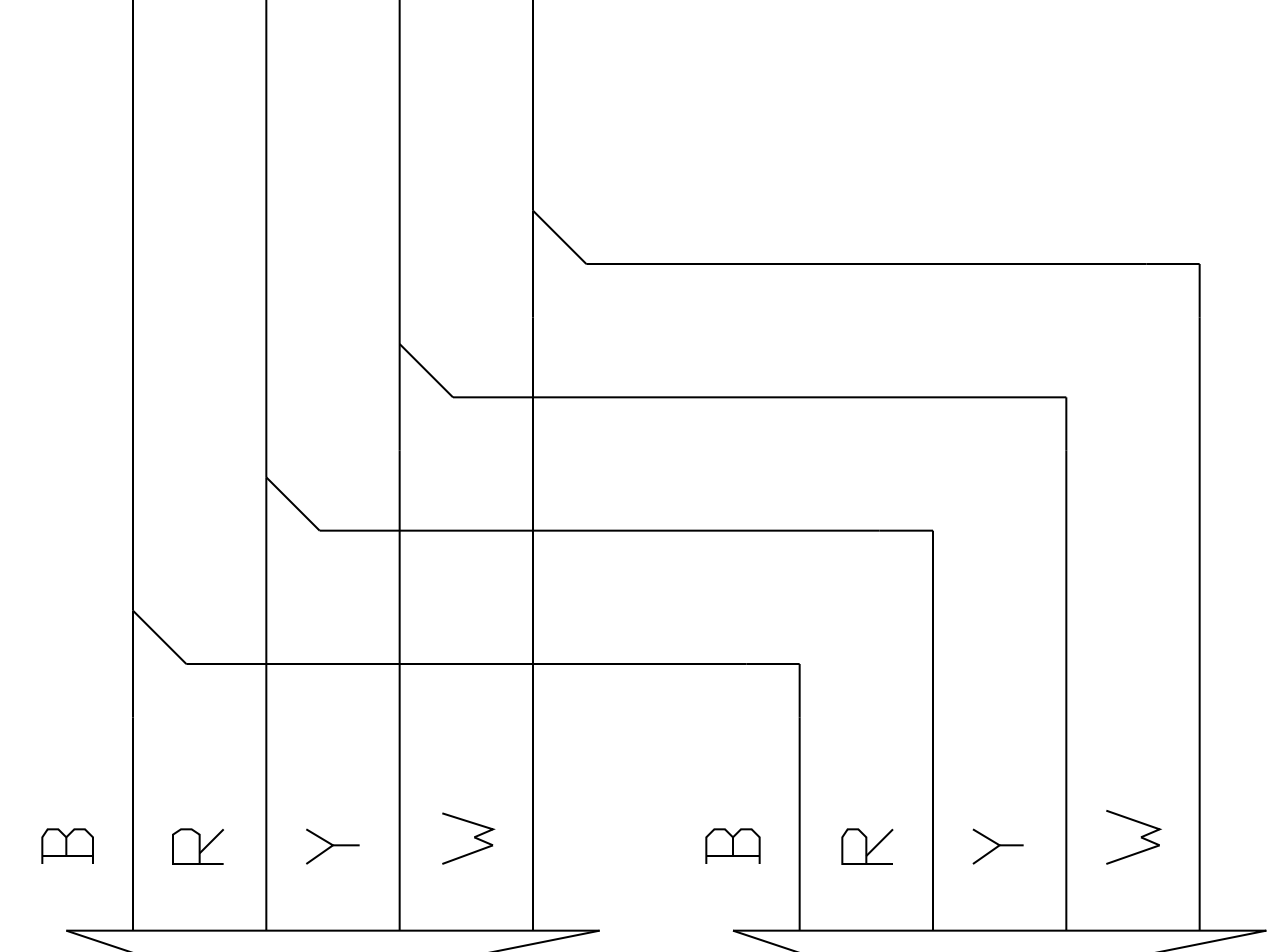
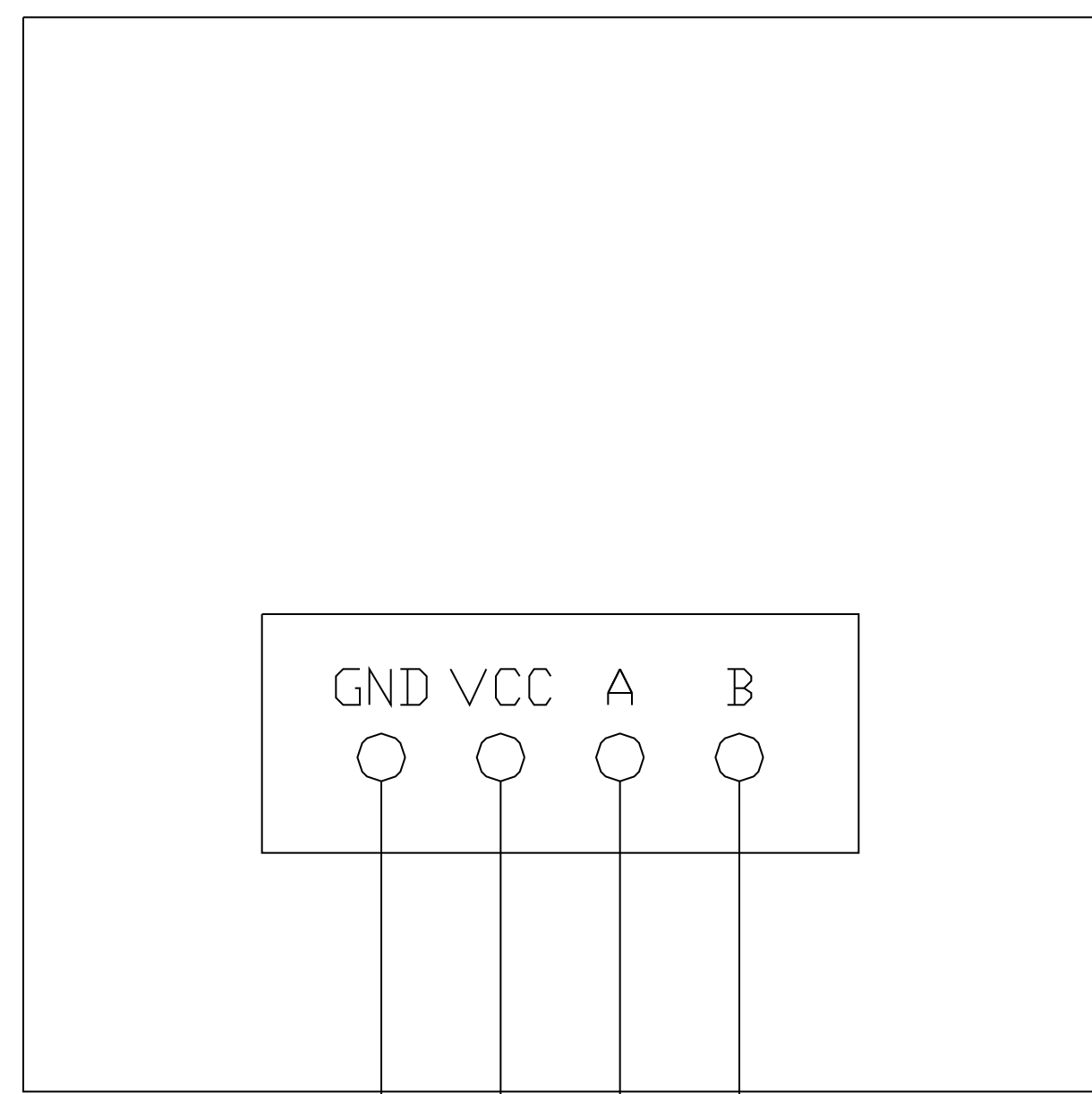

C-TP00

C-TP01

TGP01  
TGP-4A-01-IQ

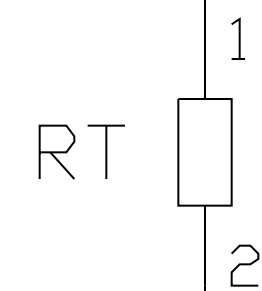
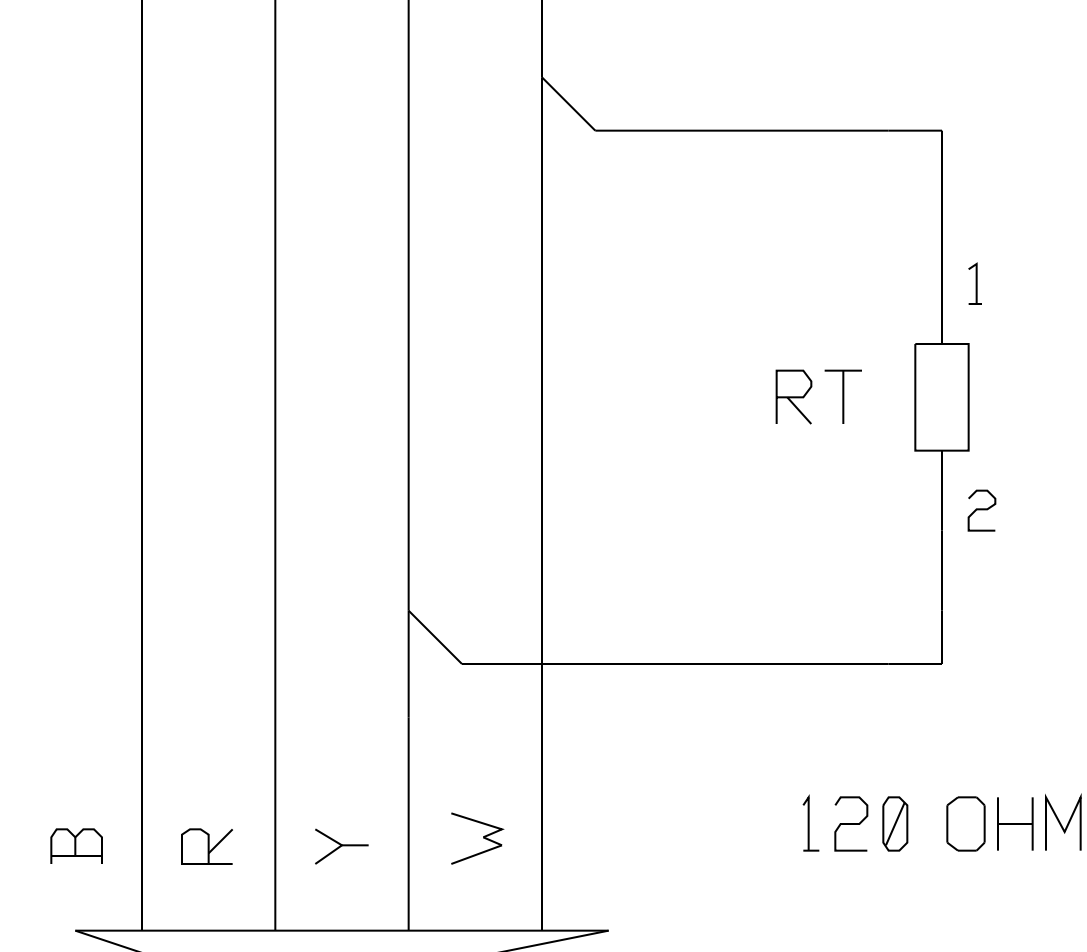
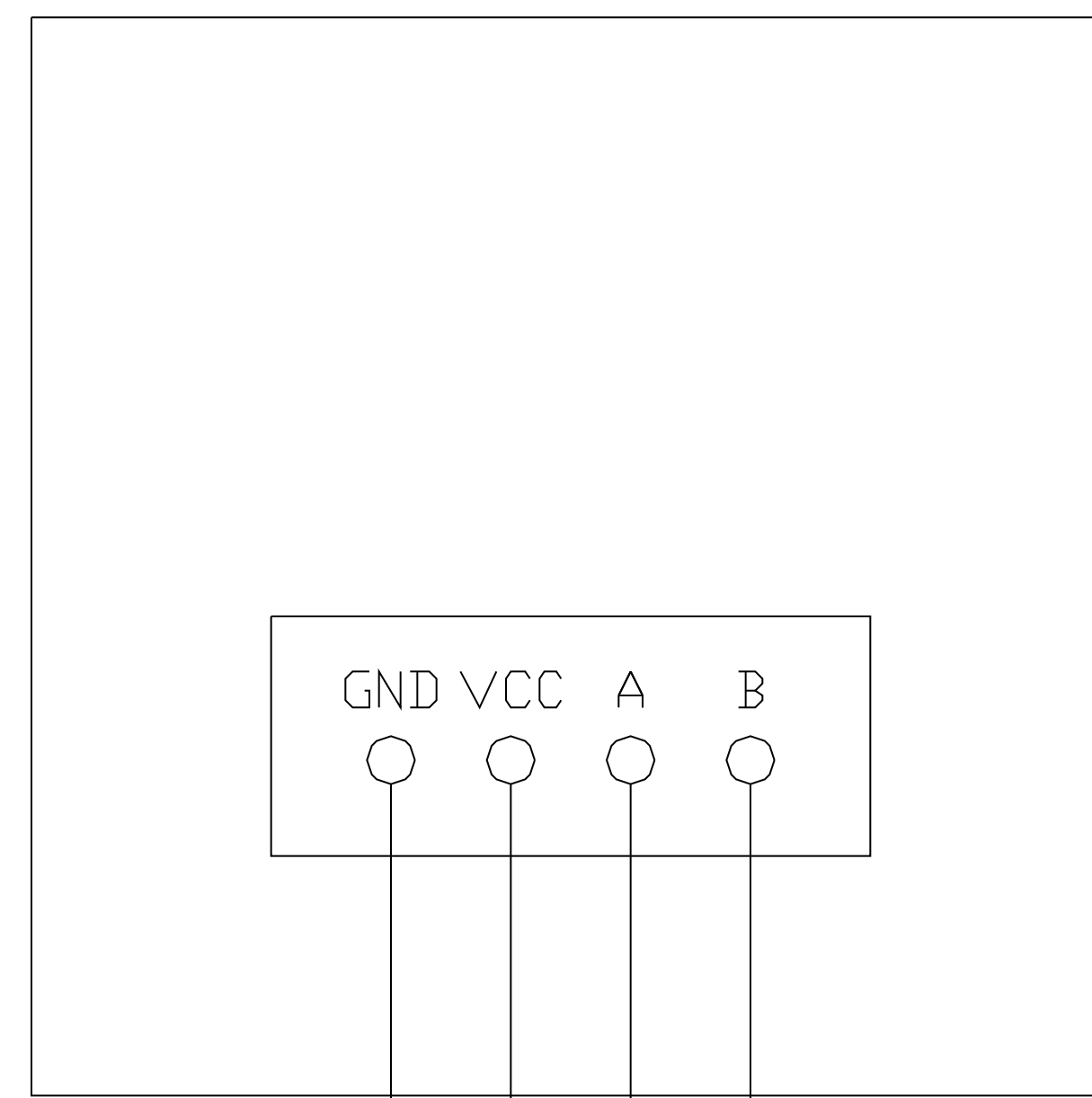

120 OHM

C-TP01

7.9 [RS485]

ROOM TOUCH PANEL

OPTIONAL  
CORRIDOR TOUCH PANEL  
Near room entry

				Last changed by GK	 Robotina d.o.o. OIC Kozina 38 SI-6240 Kozina	CONTROL SYSTEM	Drawing number GRMS-001	Installation =
			Last changed 4/6/2024	Pages 12			Location +	
Rev	Revision text	Signature	Date	Print date 4/6/2024			HIQ GRMS	Page number 8



VALVES

FAN

IX

TS

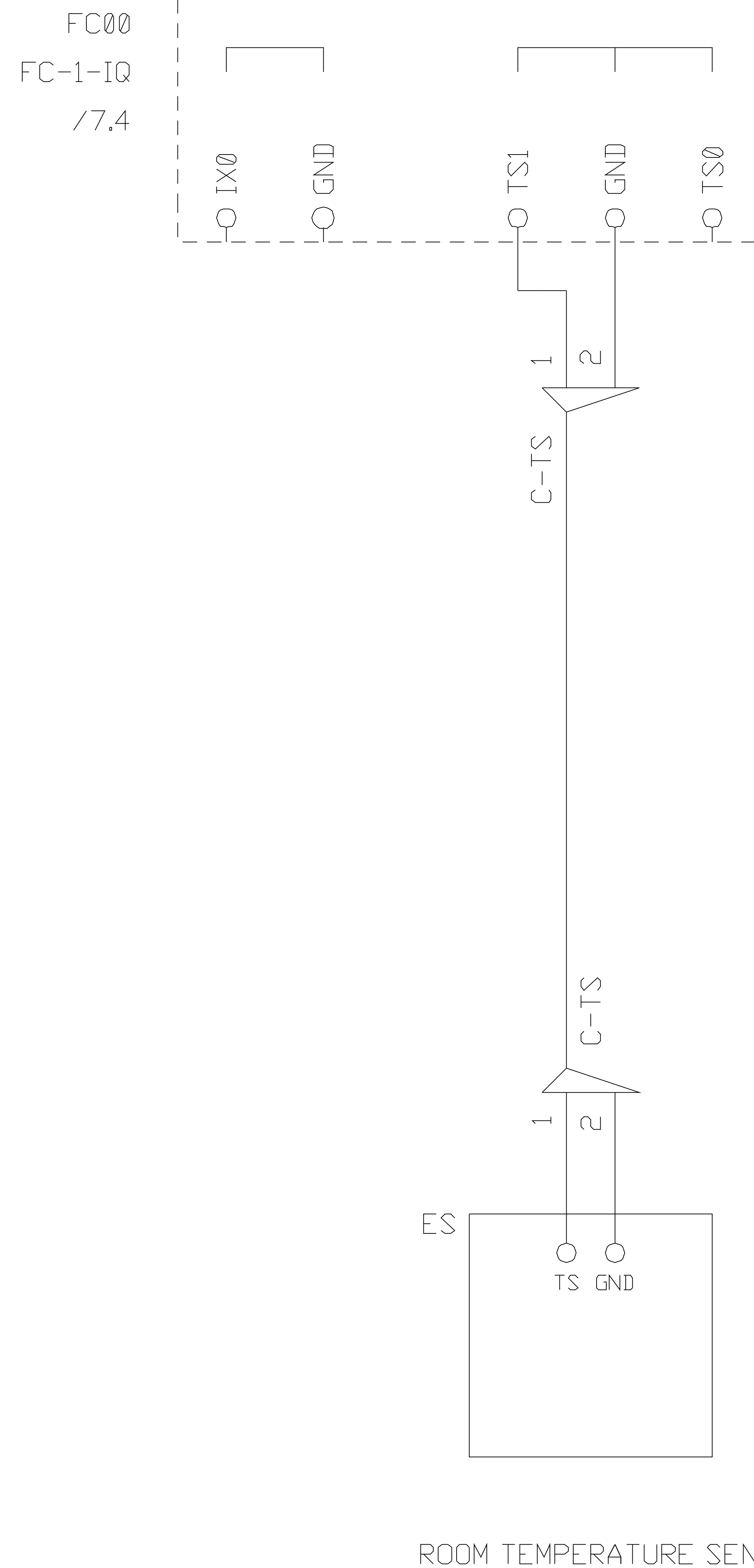
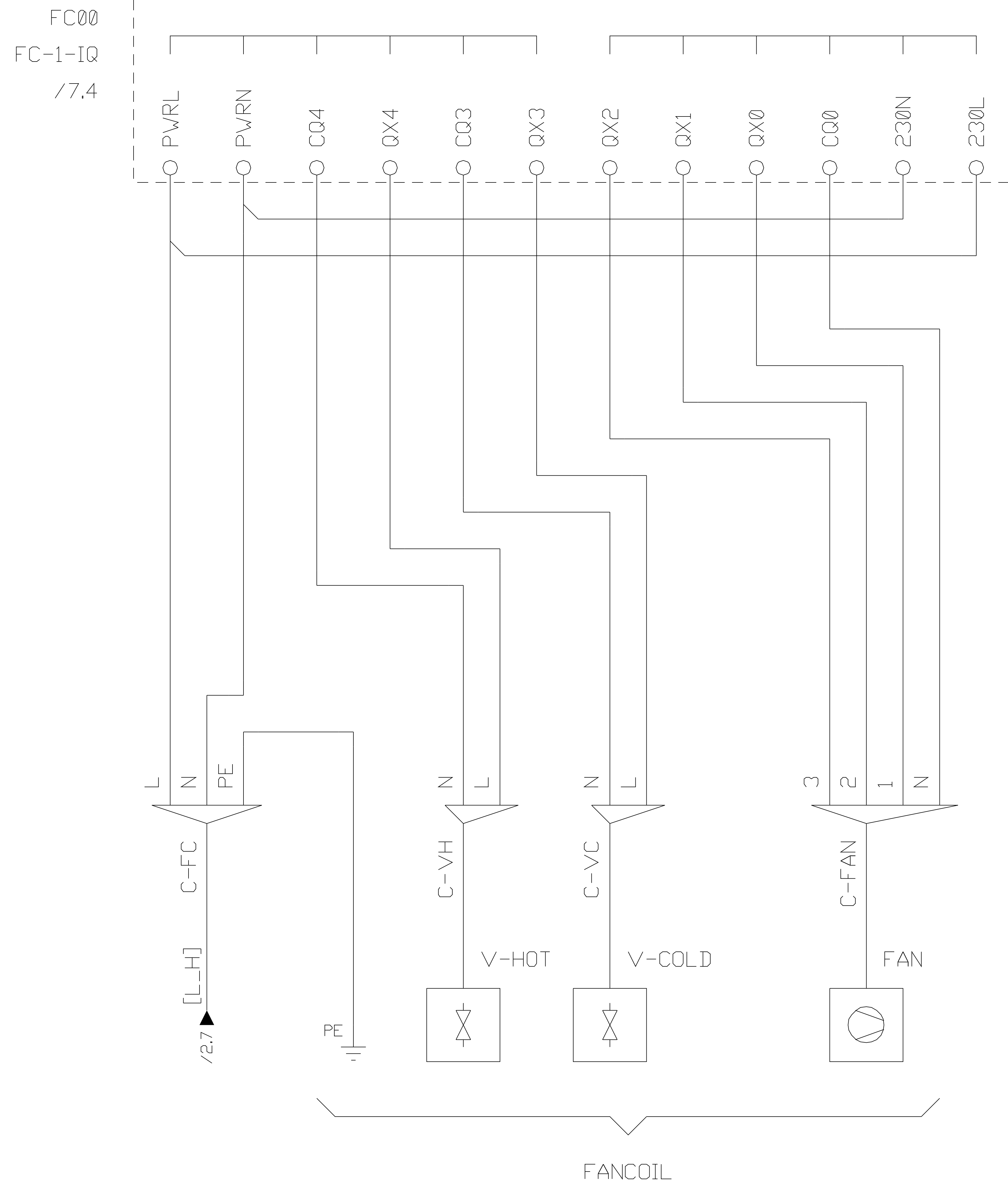

				Last changed by GK	 Robotina d.o.o. OIC Kozina 38 SI-6240 Kozina	CONTROL SYSTEM	Drawing number GRMS-001	Installation =
				Last changed 4/6/2024		HIQ GRMS	Pages 12	Location +
Rev	Revision text	Signature	Date	Print date 4/6/2024				Page number 9

### Facility LAN

### IOT Linker

### Control LAN

### Master Controllers

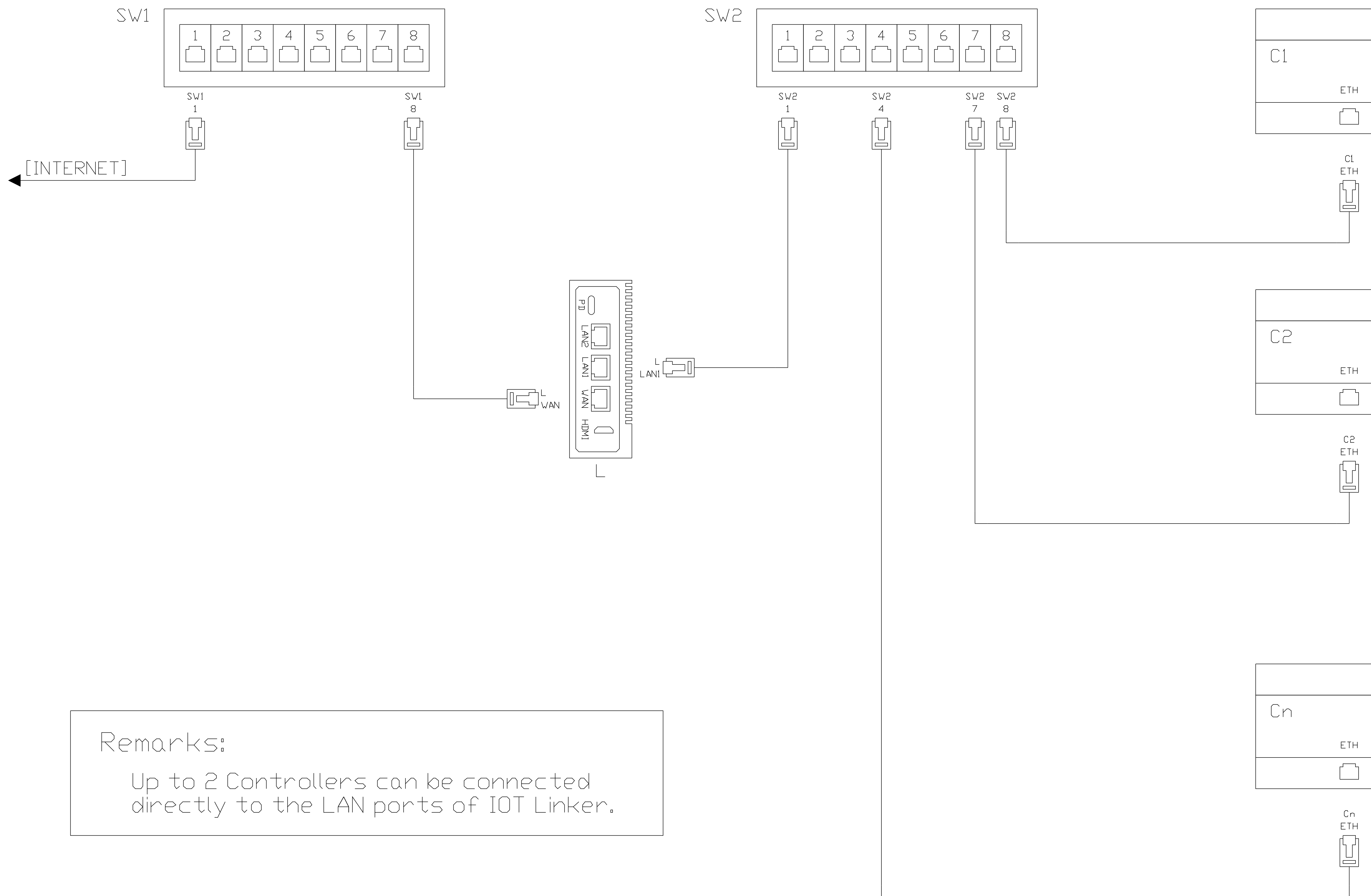

Remarks:  
Up to 2 Controllers can be connected directly to the LAN ports of IOT Linker.

				Last changed by GK	 Robotina d.o.o. OIC Kozina 38 SI-6240 Kozina	CONTROL SYSTEM	Drawing number GRMS-001	Installation =
				Last changed 4/6/2024		HIQ GRMS	Pages 12	Location +
Rev	Revision text	Signature	Date	Print date 4/6/2024				Page number 10

CORRIDOR

ROOM

FANCOIL

DISTRIBUTION BOX

3 speed fan  
Hot water valve  
Cold water valve

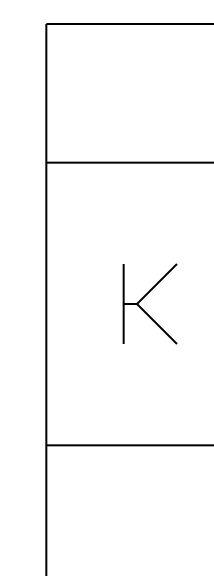
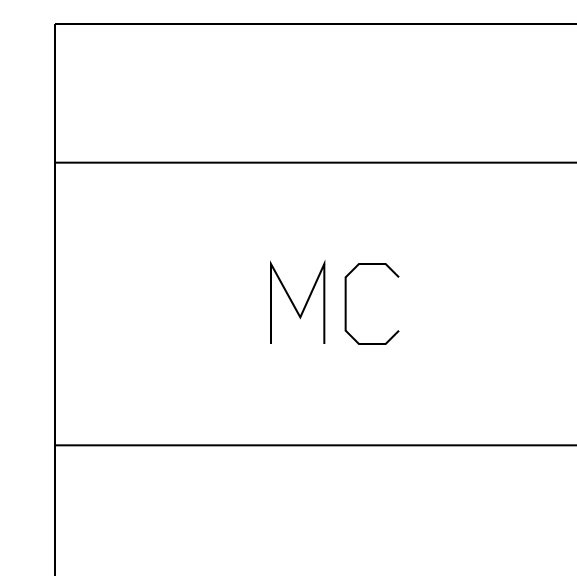
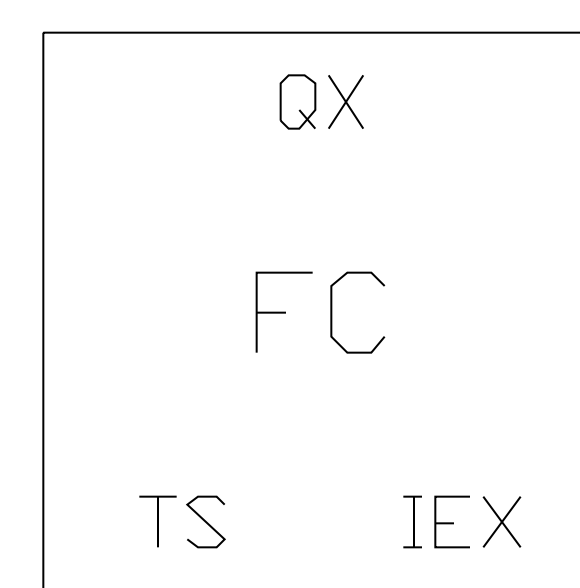
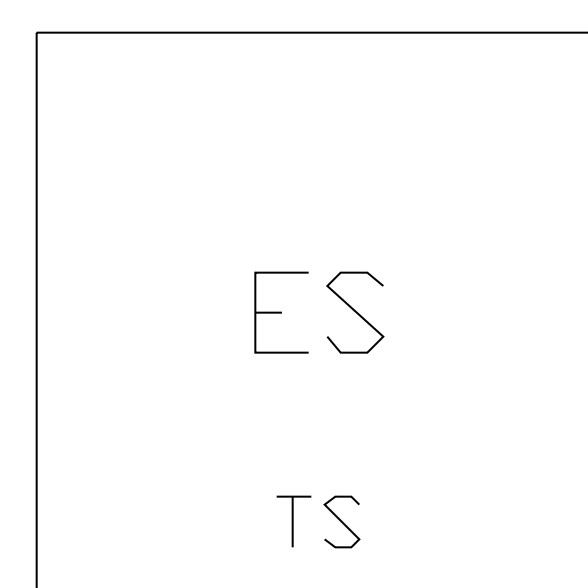
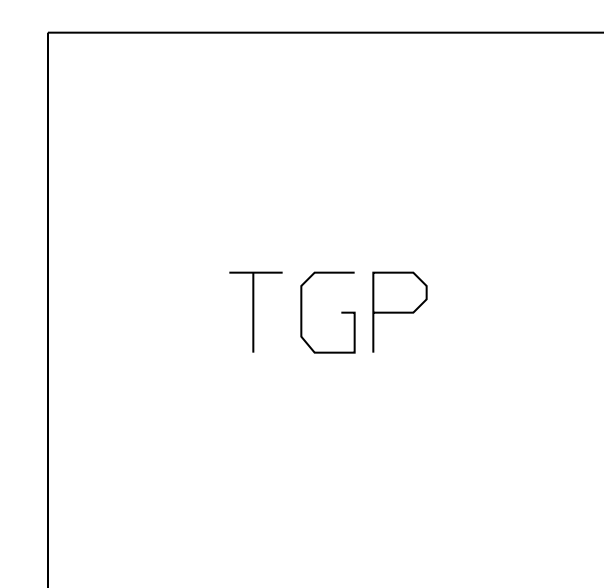

4 x 0.75

2 x 0.75

4 x 0.75

4 x 0.75

5 x 0.75

(N+1) x 0.75

4 x 0.75

2 x 0.75

2 x 1.5

3 x 1.5

3 x 1.5

3 x 2.5

- Push-buttons
- Motion-sensors
- Door / window sensors
- Door lock
- Wellcome Light
- Lights power supply
- Power sockets

				Last changed by GK	 Robotina d.o.o. OIC Kozina 38 SI-6240 Kozina	CABLING	Drawing number GRMS-001	Installation =
				Last changed 4/6/2024		HIQ GRMS	Pages 12	Location +
Rev	Revision text	Signature	Date	Print date 4/6/2024				Page number 11

1	2	3	4	5	6	7	8	9	10	11	12
---	---	---	---	---	---	---	---	---	----	----	----

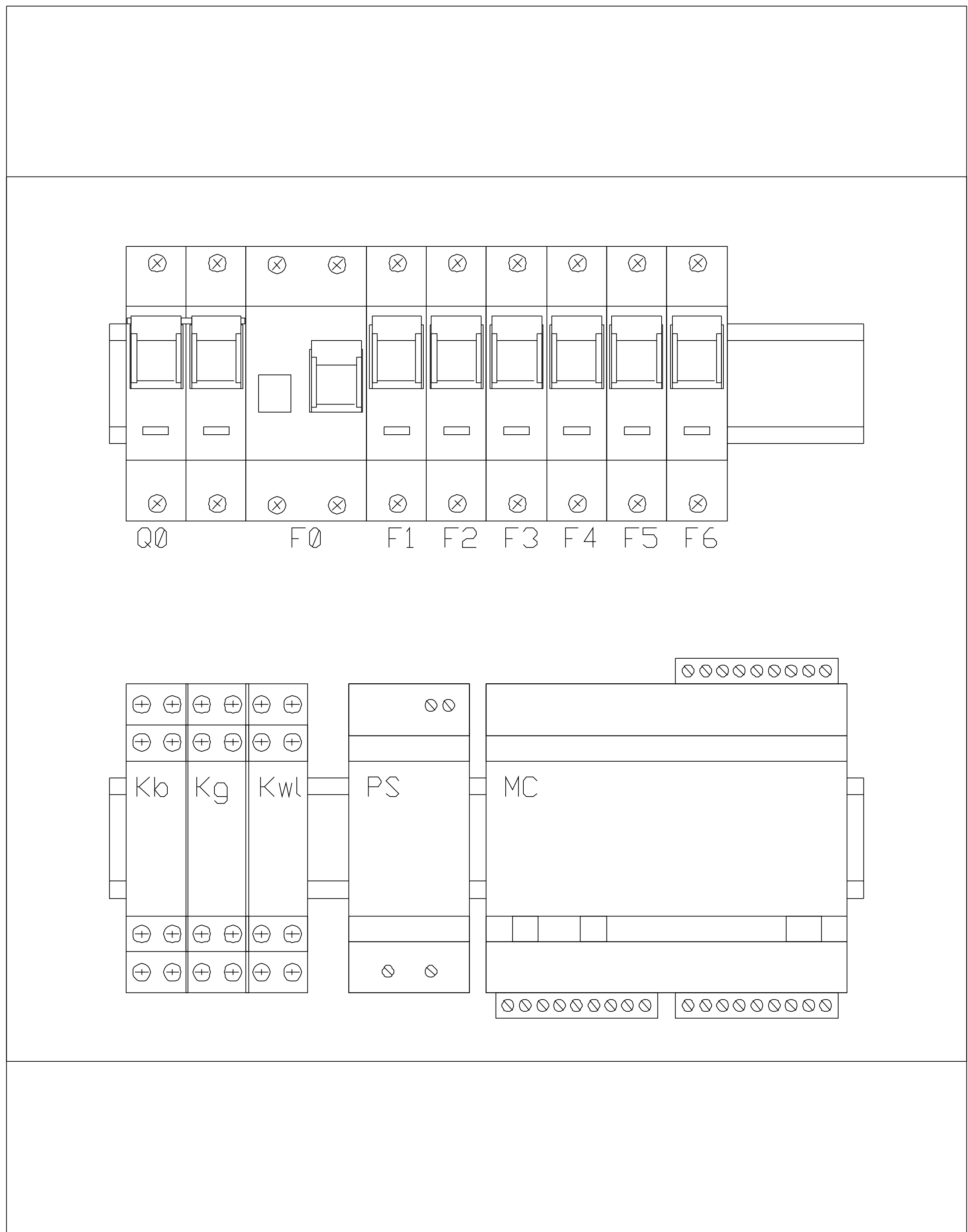

				Last changed by GK	 Robotina d.o.o. OIC Kozina 38 SI-6240 Kozina	CABINET LAYOUT	Drawing number GRMS-001	Installation =
				Last changed 4/6/2024		HIQ GRMS	Pages 12	Location +
Rev	Revision text	Signature	Date	Print date 4/6/2024				Page number 12